



We've made a handy video version of this fitting guide, just click the play button to view it.

If you prefer to print the instructions or simply to follow step-by-step, just keep reading.

Fitting the brackets

1

The brackets offer two methods of installation:

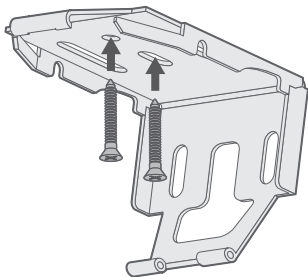

Top-Fixing

Where the brackets are screwed into the lintel (or 'ceiling' of the recess)

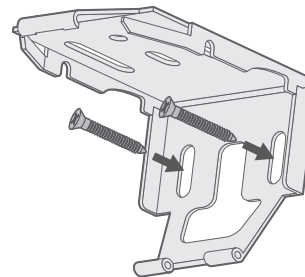

Face-Fixing

Where the brackets are screwed onto a facing surface (a wall or window frame)

Space the brackets evenly across the width of the blind, with the outermost ones a few centimetres in from the ends.

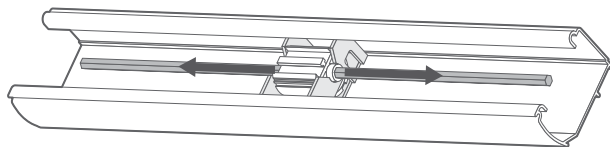

Whilst deciding where the brackets will be fitted, take a moment to make sure that they are not in a position such that they will interfere with the components inside the blind's headrail.

If you have requested side-fixing accessories (not sent as standard) with your brackets then these will be included with the fittings.

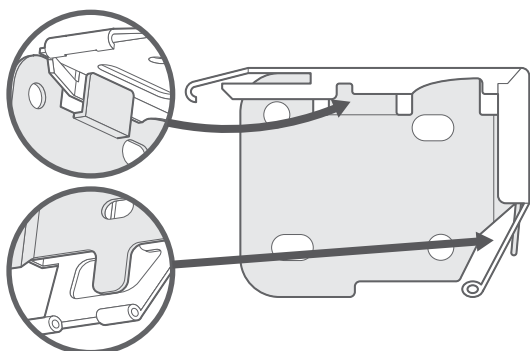

Slot the side-fixing accessory into the inside of the bracket as shown, then use the provided fittings to secure them together.

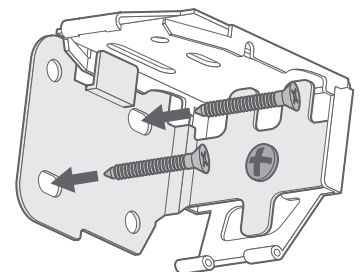
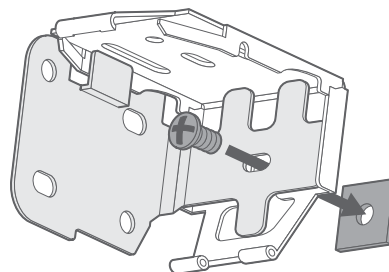

Use the holes in the side-fixing accessory to side-fix the bracket into the recess.

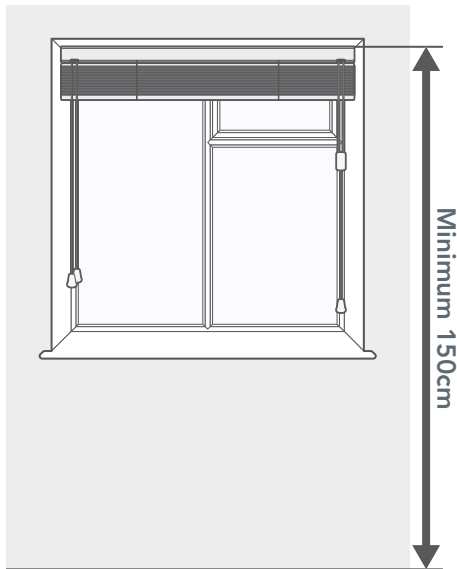

For safety reasons, always ensure that the top of the blind is installed at least 150cm (1500mm) from the floor.

Fitting the blind

2

If you are fitting the blind inside a recess, go to step 3 before step 2.

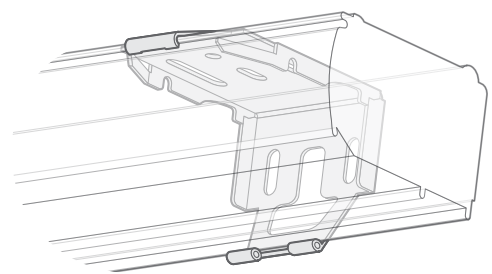
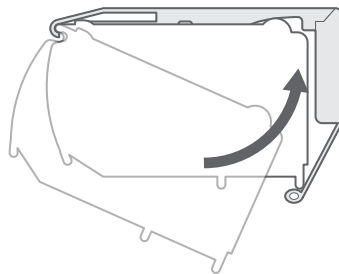
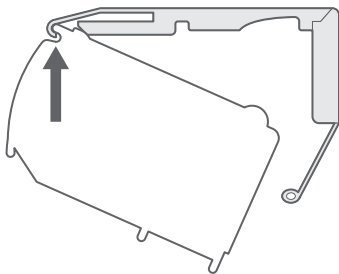

Holding the rail at an angle with the back tipped downwards, locate the front lip at the top of the headrail into the front hook of the bracket. Then, push the back of the headrail upwards until the bracket's rear hook snaps into place.

When the headrail is securely inserted into the bracket, you will be able to see the front (top) and back (lower) catches of the bracket.

Top Tip

If you pull the cords to tilt the blind but the slats do not move:

- Make sure the slats are open and that the tilt cords are both the same length.
- Stack the blind up tightly and lock it off, then take it down from the brackets.
- Push the metal rod inside the headrail all the way over to the left, so that it is connected to the tilting mechanism.

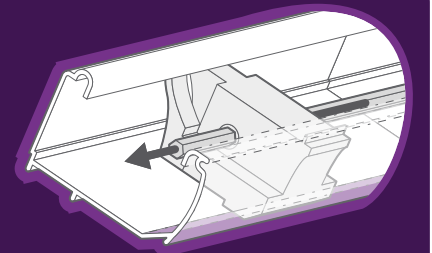

Fitting the pelmet

Attach the winged clips to the rear of the pelmet and hook the serrated pelmet clips onto the headrail (if installing the blind within a recess, this should be done before step 2) so that both the serrated clips and winged clips are in corresponding positions on the headrail and pelmet. Then align the two clips with each other and apply gentle pressure to the front of the pelmet, directly over the clips to click them together.

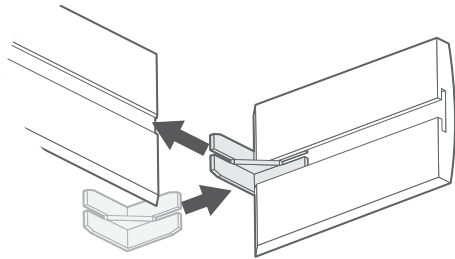
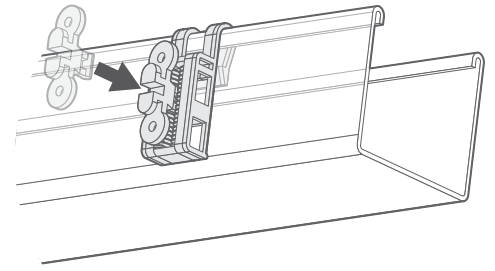
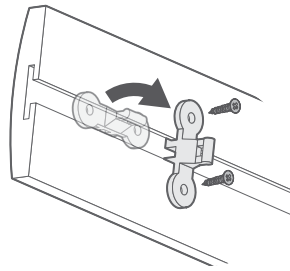

Pelmets for 'Exact Fitting'

If you've ordered 'exact fitting' then the pelmet will be sent wider and mitred at the ends, with additional end returns to cover the brackets. Use the 'L' shaped plastic brackets from your fittings pack to attach the side returns to the pelmet.

Cord Condenser

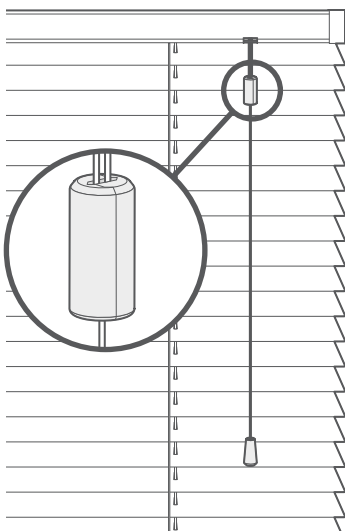

A breakaway cord condenser is pre-fitted to the lift cords so that when a horizontal force is applied to the cords above the condenser, it safely breaks away, eliminating any hazardous loops.

Top Tip

The design of the condenser can vary, so don't worry if yours doesn't look exactly like the illustration. Both designs do the same job and clip back together in the same way.



If the cord condenser is pulled apart:

- Untwist the cords so that they're nice and straight.
- Slot the cords into the channel in the centre of one half of the condenser. If your condenser differs slightly from the diagram, don't worry, just slot any cords that aren't already tied into place inside in the same way.
- Click the two halves back together, ensuring there is no loose thread trapped at the edges of the condenser.

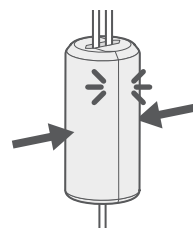
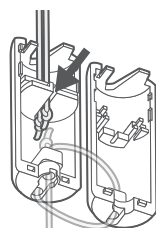

Child Safety



Young children can be strangled by loops in pull cords, chains, tapes and inner cords that operate the product.



To avoid strangulation and entanglement, keep cords out of the reach of young children. Cords may become wrapped around a child's neck.

Move beds, cots and furniture away from window covering cords.

Do not tie cords together. Make sure cords do not twist and create a loop.

Cord Safety Cleat

The safety cleat shall be installed as close to the headrail as possible and in all cases not less than 1500mm from the floor. The cord must be fully accumulated around the safety cleat(s) when the blind is not in use. Use the table below to determine the distance required between the cleats to fully accumulate the cords when the blind is fully raised.

Drop of blind	*Distance between cord cleats (centre to centre)
1-1000mm	100mm
1001-2000mm	150mm
2001-3000mm	300mm

Place the safety cleat in the desired position on the wall and mark the positions of the holes with a pencil.

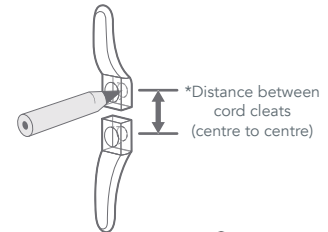

Mark the hole positions and drill as required. Use the screws provided to attach the safety cleat to the wall.

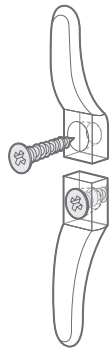

Wrap the cords around the cord cleats in a figure of 8. When the cords are fully accumulated, ensure they are secure so that when any cord is pulled, no excess cord is released.

