

**Fitting the brackets**

Our wooden blinds are supplied with box brackets, these offer you three methods of fitting:

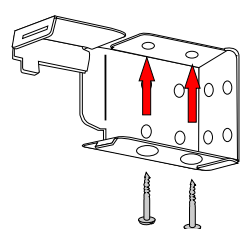

**Top-Fixing:** Where the bracket will be fixed directly to the ceiling or underside of the recess.

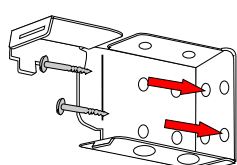

**Face-Fixing:** Where the bracket is fixed onto the wall or straight onto the window frame.

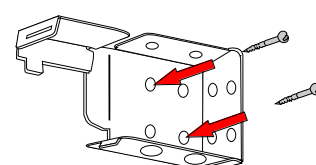

**Side-Fixing:** Where the bracket is fixed on the side wall of a recess.

Wider blinds will be supplied with support brackets. These should be positioned towards the centre of the window area in-line with the box brackets. Make sure that the position of the support bracket is clear of any cords coming out of the head rail. Support brackets can be top-fixed or face-fixed.

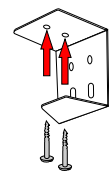

Top-Fixing

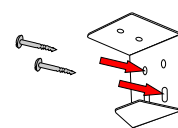

Face-Fixing

**Installing the Blind**

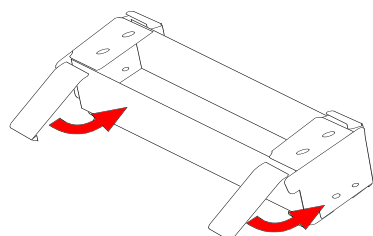

Once the brackets have been installed, move the latches to the open position (so that they point away from the window) and slot the head rail of the blind into the box on each side, then close the latches to secure the blind in place. There will be an audible 'click' when the latch has closed fully.

**Top Tip**

If you pull the cords to tilt the blind but the slats do not move, take down the blind and take a look in the top; slide the metal rod to the left until it's fully engaged with the tilt mechanism

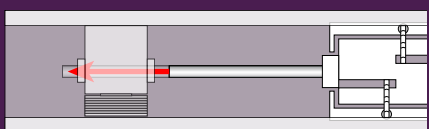

**2**

**Attaching the pelmet**

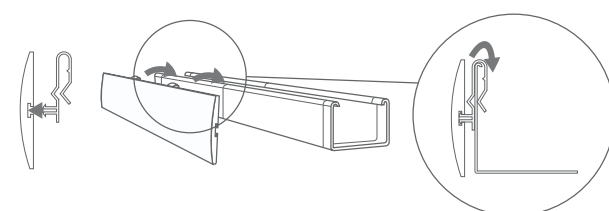

Attach the clear pelmet clips to the faux-wood pelmet by pushing them firmly into the groove on the back of the pelmet.

Then hook the clips over the lips on the head-rail to attach the pelmet to the blind.

**3**

**Note for fitting into a recessed window:**

You may find that you have to trim the wood pelmet to fit your recessed window area. This is because when the size of the width is submitted it is the smallest point of the recess. As we have no way of telling if this is at the top, middle or bottom of the recess, we supply the pelmet long enough to cover any potential gaps at the top of the recess area.

To trim the pelmet, wrap the end of the pelmet with masking tape and draw the line onto the tape, this will avoid ink marks being left on the timber and also helps to prevent any splintering. Use a junior hacksaw or a fine tooth tenon saw to make the cut, the fine tooth blade will leave a smooth finish and also prevent the risk of splintering,

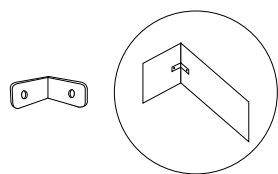

The two 'L' shaped stainless steel brackets are supplied to allow you to attach the returns to the main pelmet. They are not needed if you are mounting the blind inside a recess.

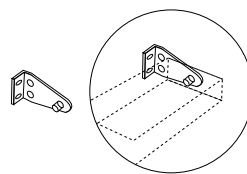

There are two clear plastic clips supplied. These allow the bottom bar to be pinned in place if you mount the blind onto a door area. They are not required for window installations.

**Child Safety**

**4**

**Cord Condenser**

A breakaway cord condenser is pre-fitted to the lift cords so that when a horizontal force is applied to the cords entering the condenser, it safely breaks away eliminating any hazardous loops.

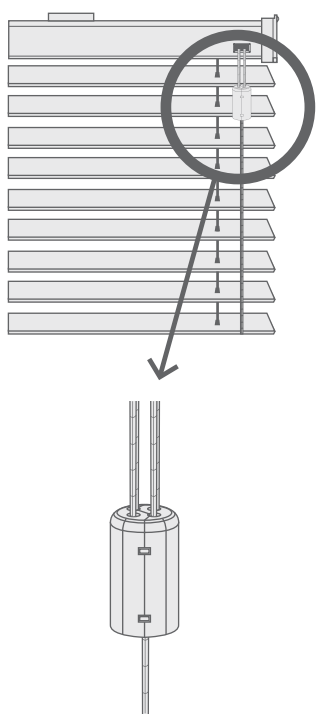

If the cord condenser is pulled apart:

Untangle and untwist cords.

For 2 cords: Press the cord condenser together until it is fully closed.

For 3 cords: Place the loose cord in the opening in one half of the cord condenser and press the cord condenser together until it is fully closed.

For 4 cords: Place one of the loose cords in the opening in one half of the cord condenser, the remaining loose cord in the opening in the other half and press the cord condenser together until it is fully closed.

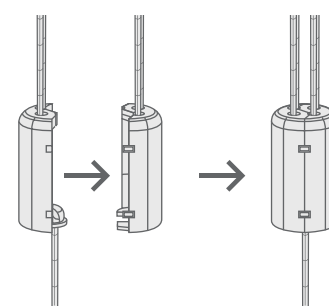
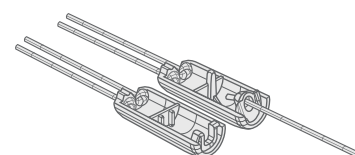

**Cord Safety Cleat**

**5**

The safety cleat shall be installed as close to the headrail as possible and in all cases not less than 1500mm from the floor. The cord must be fully accumulated around the safety cleat(s) when the blind is not in use. Use the table below to determine the distance required between the cleats to fully accumulate the cords when the blind is fully raised.

| Drop of Blind | *Distance between cord cleats (centre to centre) |
|---------------|--|
| 1-1000mm      | 100mm  |
| 1001-2000mm   | 150mm  |
| 2001-3000mm   | 300mm  |

Place the safety cleat in the desired position on the wall and mark the positions of the holes with a pencil.

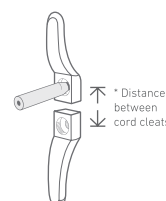

Mark the hole positions and drill as required. Use the screws provided to attach the safety cleat to the wall.

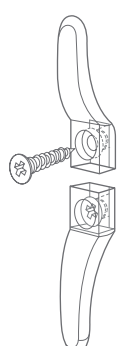

Wrap the cords around the cord cleats in a figure of 8. When the cords are fully accumulated ensure any cord is secure so when any cord is pulled no excess cord is released.

