

Turn your phone or tablet

Our guides are best viewed in landscape if you're viewing on your phone or tablet.

Our Top Tips for Measuring

Even if you have no DIY or measuring experience, don't worry – measuring is easy! The following pages will guide you through how to measure for your beautiful new blinds, but here are some general tips to keep in mind as you measure:

- ✓ Always use a metal tape measure – cloth or plastic ones can stretch, giving you inaccurate measurements
- ✓ Double check everything! If you're even slightly unsure about a measurement you've taken, measure again until you're certain
- ✓ Measure to the nearest millimetre, or to the nearest fraction if you're measuring in inches



Don't worry! Even if your measurements aren't quite right, our SureSize measuring guarantee has you covered.

Is your window suitable?

Our Stick On Shutter Blinds are mounted directly onto your window or door frame. The shutter will be made larger than the glass, overlapping onto the frame on all sides. Before measuring, check that the window or door frame can accommodate these blinds.

- ✓ If your frame has an angled or bevelled inner edge, check that this is not too wide
- ✓ Check that any vents or handles on the window frame aren't close enough to the glass to prevent the blind from fitting

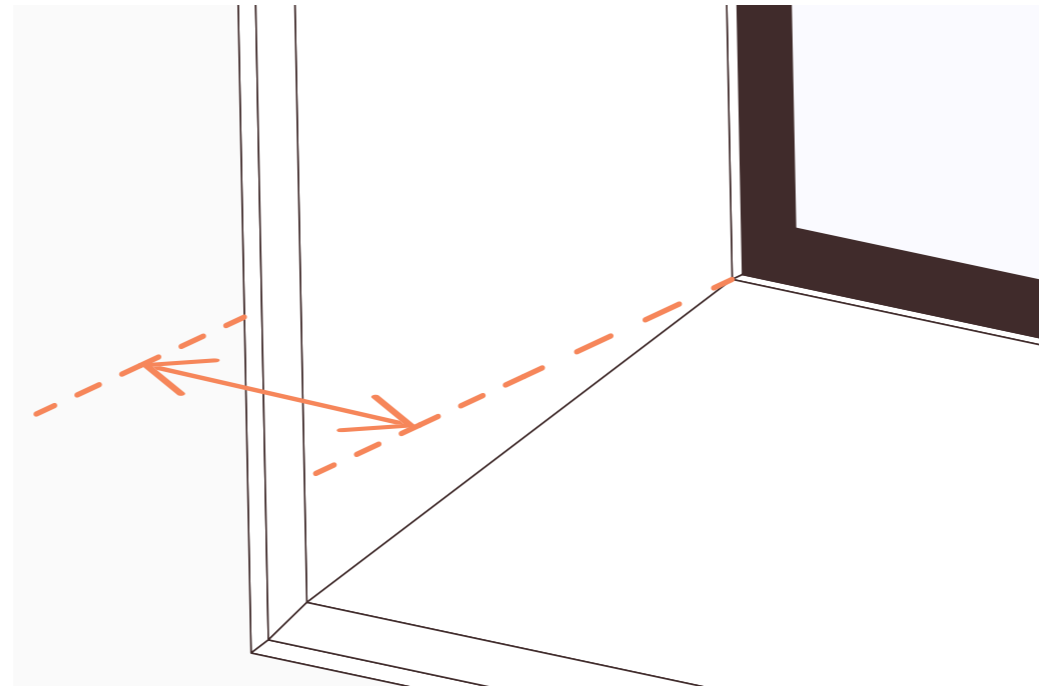

1

Measure the inner frame width

If the inside edge of the window frame is angled, shaped or bevelled, you'll need to check how wide this section of frame is. *It must be less than 20mm.*

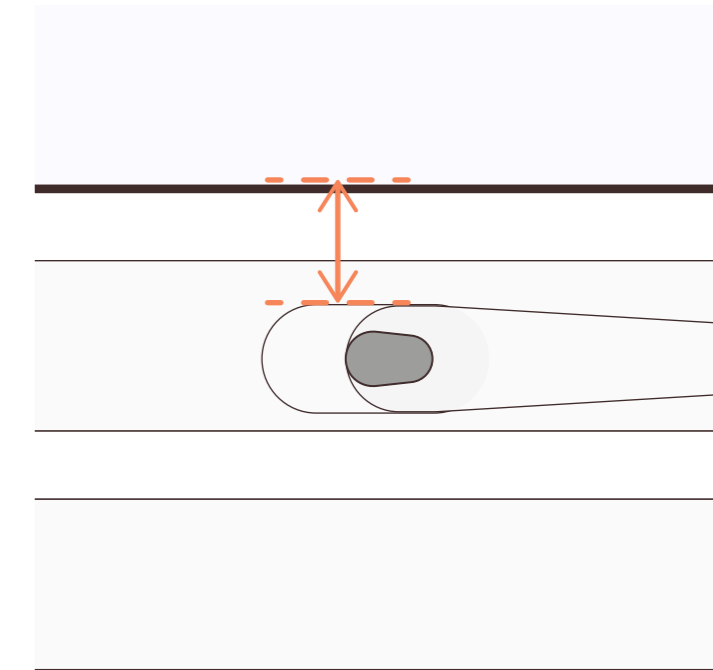

2

Measure from the glass to obstructions

Measure from the edge of the visible glass to the edge of any vents or handle mounts on the frame – *this distance must be 25mm or more at the top and each side, and at least 40mm at the bottom.*

Measuring the *Visible Glass*

Why Measure the glass?

Our Stick On Shutter blinds are designed to cover the glass area of your window or door. Whilst the blind will be made larger than the glass size, we think the glass is the simplest thing to measure. So all we need is the measurements of the glass, we'll make the necessary adjustments to ensure your blind fits perfectly.

- ✓ Measure the glass in several places and use the smallest measurement
- ✓ Measure each pane individually, you'd be surprised how much they can vary in size even if they all look the same
- ✗ Do not make any deductions or allowances in your measurements

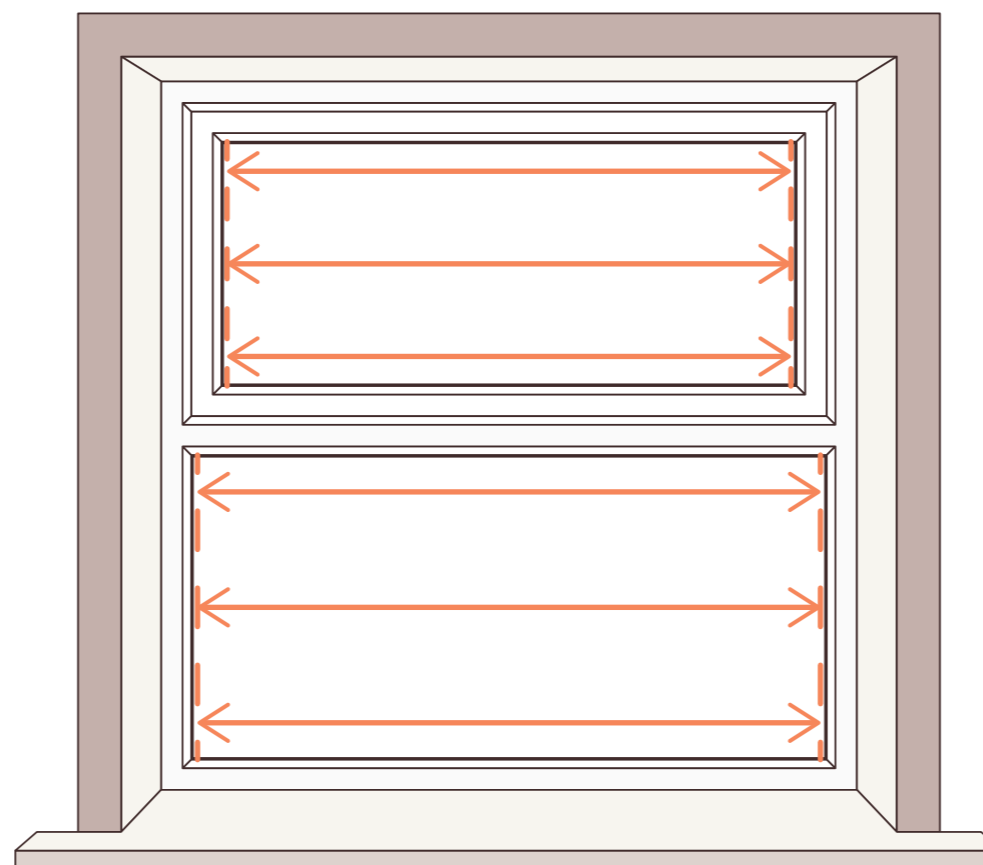

1 Measure the width

Measure the width of just the visible glass. Measure at the top, in the middle and at the bottom, and only note the smallest measurement.

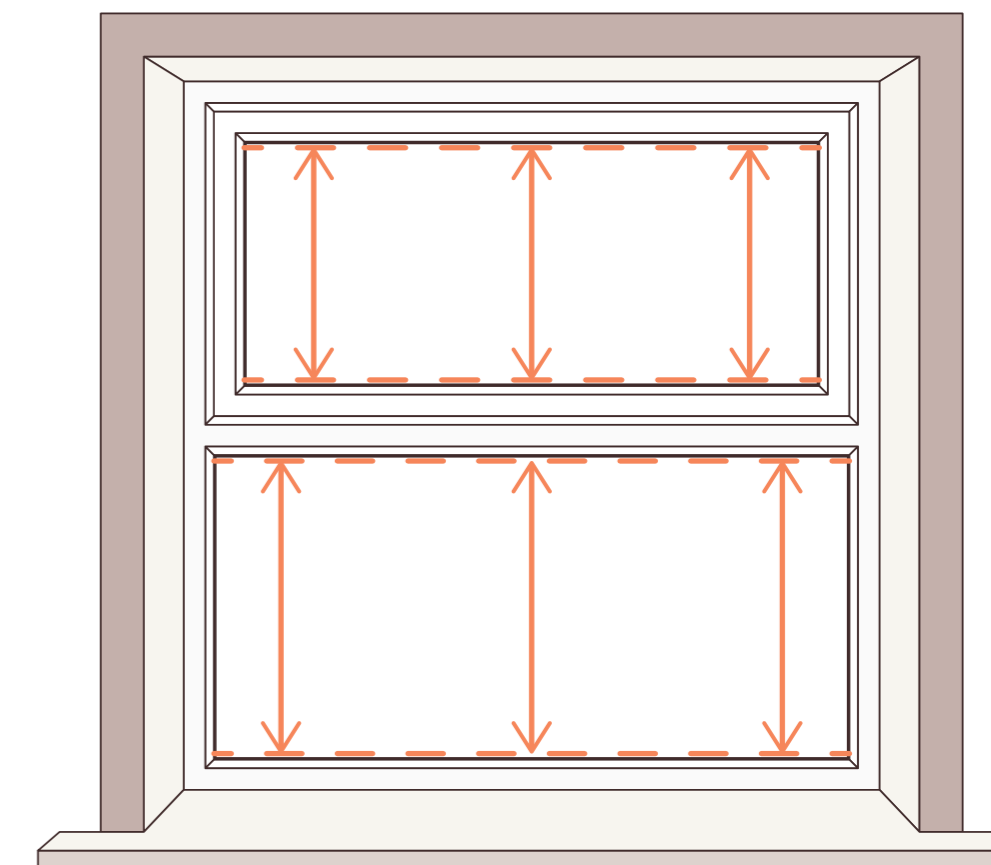

2 Measure the drop

Measure the drop in the same way. Measure on the left, in the middle and on the right, noting down the smallest measurement.

Why Measure for handles?

If you have a window handle then your shutter's frame can be shaped so that the handle can pass in front of it without scraping against it. To accommodate this, we'll just need to know where your handle is on the frame, and the distance from the far side of the window to the centre of the handle.

- ✔ Measure the distance from the far side of the glass to the centre of the handle's pivot point
- ✔ Adjust where you measure from based on the handle's position

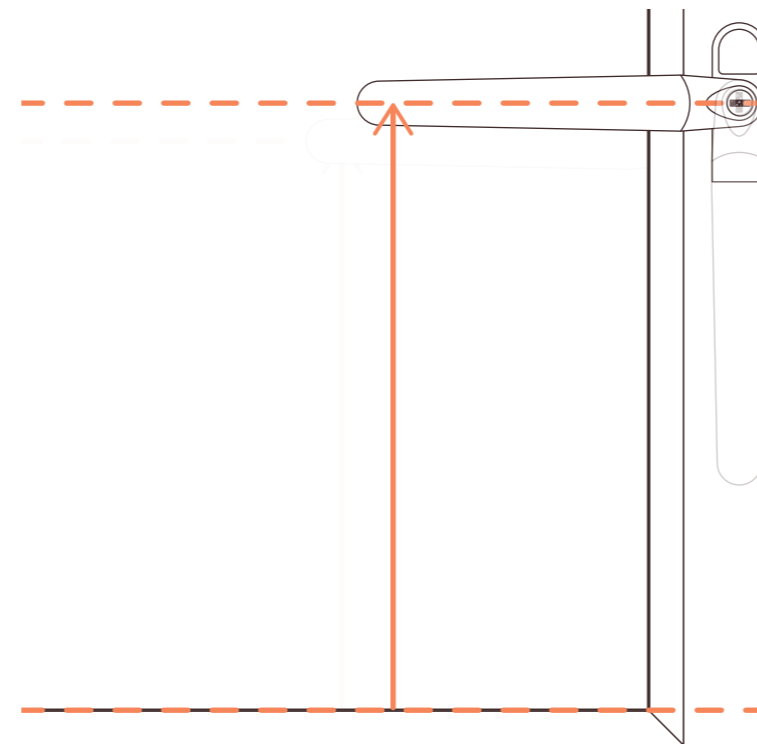

Measure the handle's distance from the edge of the glass

Turn the handle to its open position and look at where it pivots on its mount. Measure from the edge of the glass to the centre of this pivot point.

If your handle is on the left or the right of the window frame, *measure up from the bottom of the glass.*

If your handle is on the top or bottom of the window, *measure from the left edge of the glass.*

Top Tips *Handle Measuring*

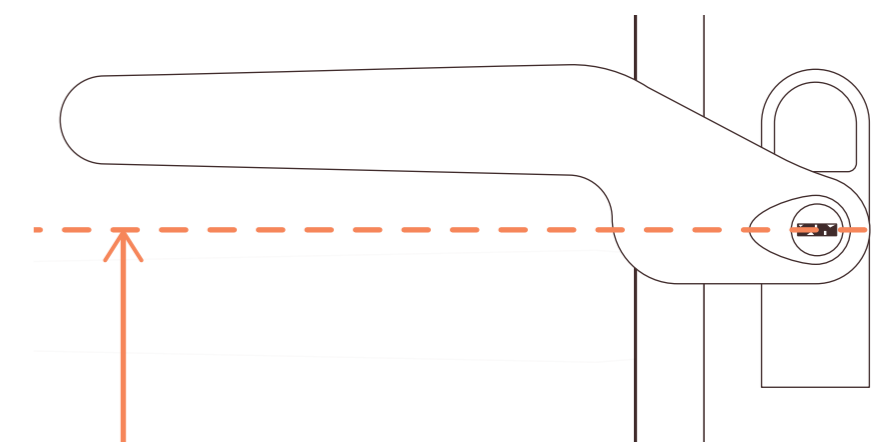
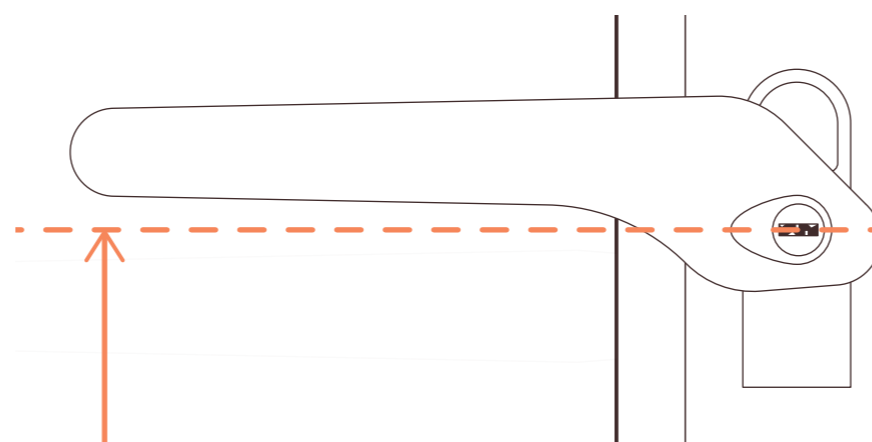
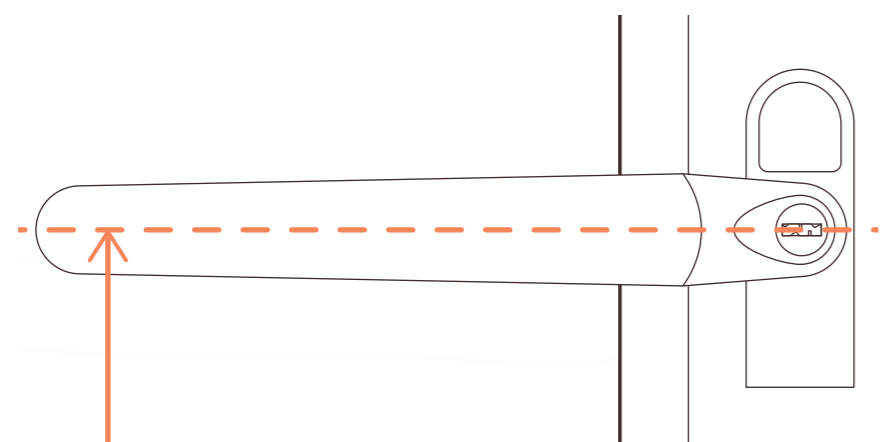

Measure the same regardless of the handle's shape

Handles come in a huge variety of shapes and designs, but you should always measure in the same way: turn the handle open, identify where the handle pivots on its mount, and measure to the centre of the pivot point, not the centre of the handle or its mount.