

Installing Roller Blinds is easy-peasy, we've made sure of it! Our guides will take you step by step through fitting your gorgeous new blinds in no time, and we've even made some handy video guides to accompany them. Choose the guide from the list below that matches the options you've chosen for your Roller Blind.

---

## Standard Roller Blinds

**Standard Roller Blinds**

- Fitting the brackets
- Fitting the blind

[Page 2](#)

**Standard Roller Blinds**

- Child Safety

[Page 3](#)

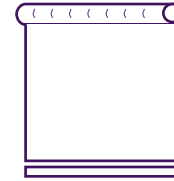

---

## SmartView Electric Roller Blinds

**Standard Roller Blinds**

- Fitting the brackets
- Fitting the blind

[Page 4](#)



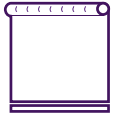

We've made a handy video version of this fitting guide, just click the play button to view it.

If you prefer to print the instructions or simply to follow step-by-step, just keep reading.

## Fitting the brackets

1

The brackets offer three methods of installation:

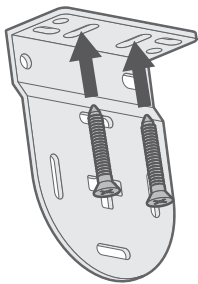

### Top-Fixing

The brackets are screwed into the lintel (or 'ceiling' of the recess)

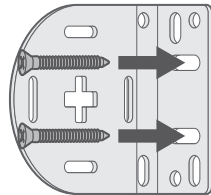

### Face-Fixing

The brackets are screwed onto a facing surface (a wall or window frame)

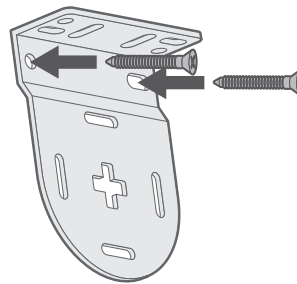

### Side-Fixing

The brackets are screwed into the side walls of the recess

### Top Tip



Top-fixing or face-fixing are recommended for most installations, whereas **side-fixing is only recommended if the width you gave us was taken right at the top of the recess.**

## Fitting the blind

2

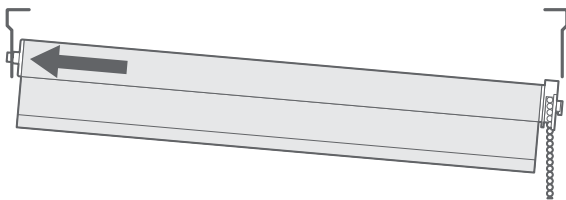

Locate the pin-end (the opposite end to the controls) of the blind into the central hole in the corresponding bracket.



Lift the control end of the blind and slot the rectangular 'lugs' into the corresponding slots on the bracket.

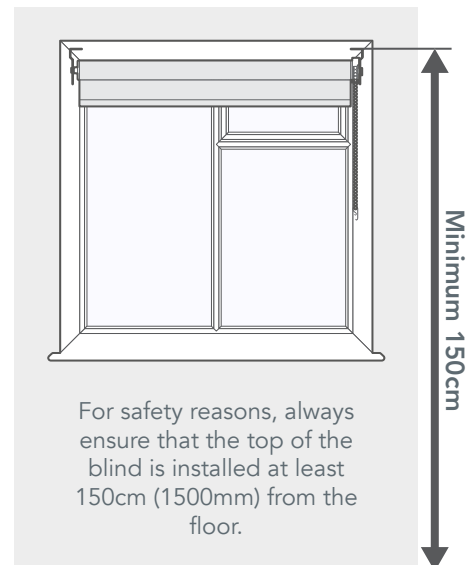

For safety reasons, always ensure that the top of the blind is installed at least 150cm (1500mm) from the floor.

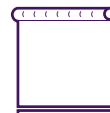

### Cord Tensioner

## Child Safety

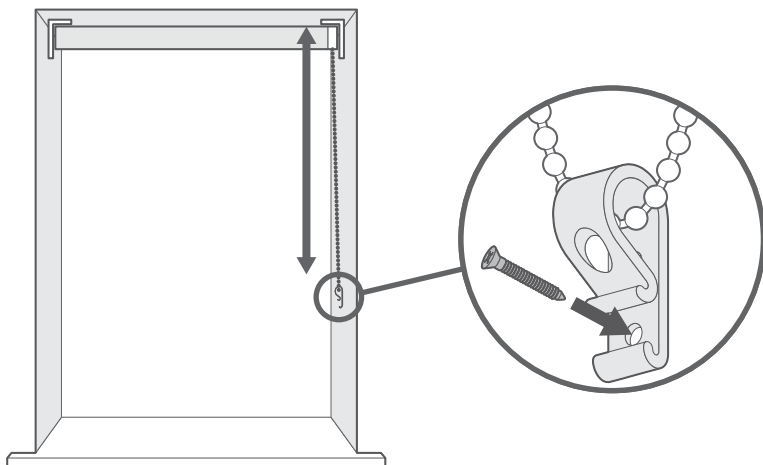

The cord retaining device must be installed at the maximum distance possible from the control mechanism to prevent looped cords from becoming slack.

Place the retaining device on the wall and mark the position of the screw hole(s) with a pencil.

Attach the retaining device to the wall using the fixings provided.



**WARNING**

Young children can be strangled by loops in pull cords, chains, tapes and inner cords that operate the product.



To avoid strangulation and entanglement, keep cords out of the reach of young children. Cords may become wrapped around a child's neck.

Move beds, cots and furniture away from window covering cords.

Do not tie cords together. Make sure cords do not twist and create a loop.



**1**

**Fitting the brackets**

The brackets offer three methods of installation:

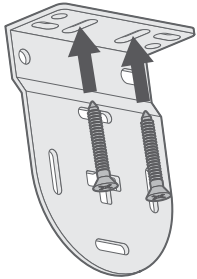

**Top-Fixing**

Where the brackets are screwed into the lintel (or 'ceiling' of the recess)

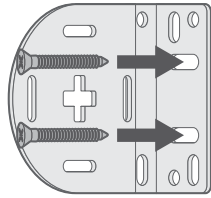

**Face-Fixing**

Where the brackets are screwed onto a facing surface (a wall or window frame)

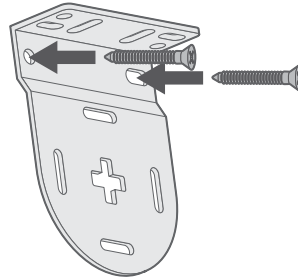

**Side-Fixing**

Where the brackets are screwed into the side walls of the recess

**Top Tip**

Top-fixing or face-fixing are recommended for most installations, whereas **side-fixing is only recommended if the width you gave us was taken right at the top of the recess.**

**Fitting the blind**

**2**

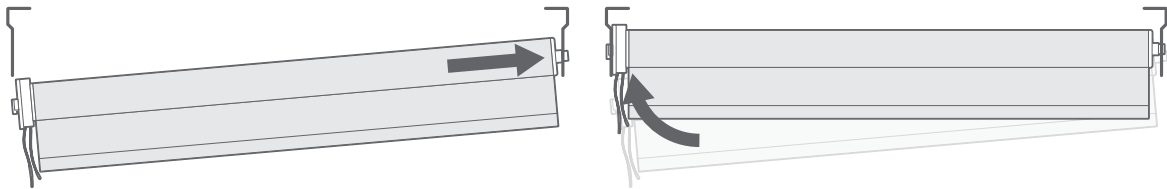

Locate the depression end (the opposite end to the controls) of the blind into the circular hole in the corresponding bracket. Lift the control end of the blind and slot the rectangular 'lugs' into the corresponding slots on the bracket.

Once your blind is installed we recommend plugging in the motor to allow it to fully charge before use. Plug the charging cable (included) into the motor charging port and allow to charge until the LED on the charger plug turns green.

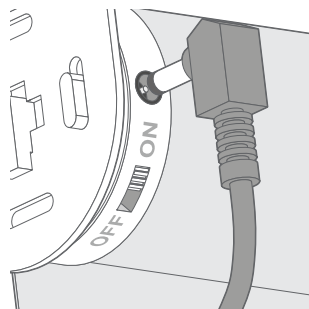

On the front of the swing tag that comes with your blind, you'll find a handy QR code you can scan with your phone. Scan this to download the SmartView app - you'll be setting up your blinds in moments!

Recycle your electrical and electronic devices free at your local recycling centre. To find your nearest centre, visit the [Recycle More](#) website and type in your postcode.



Blinds 2go Ltd is part of the DTS scheme.